

Varenummer: 0108087
 Beskrivelse: Seeger låsering JK 80 DIN 984

Mål

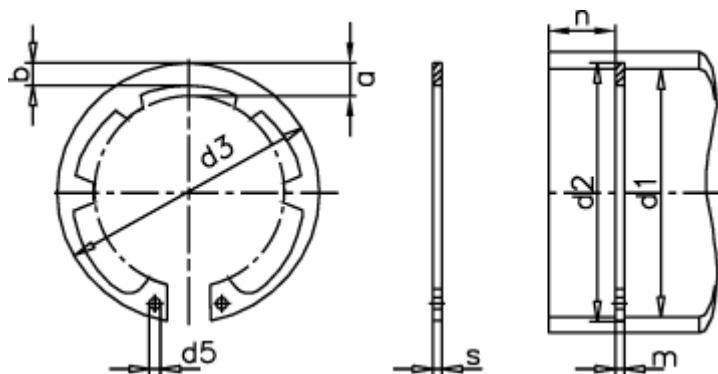

a max	= 10.2	d5 min	= 3.0	s	= 2.50
AN mm ²	= 448.0	FN kN	= 74.6	t	= 1.75
Antal takker	= 8	FRg kN	= 21.8	Tang	= ZGJ-3
b	= 7.0	FR kN	= 120.0	tol	= -0.07
Betegnelse	= JK 80	g	= 2.5	tol	= +1,30-0,54
d1	= 80	K kN-mm	= 219.0	tol	= +0,35
d2	= 83.5	m min	= 2.65	vægt kg/1000	= 25.00
d3	= 85.5	Nominal træk	= 5.3		